

FLAME115 INFRARED HEATER SERVICE MANUAL

INDEX

1. CONTROLS AND COMPONENTS
2. FLAME CONTROL CYCLES
3. MAINTENANCE SCHEDULE
4. TROUBLESHOOTING GUIDE
5. REPAIR PROCEDURES
 1. FAN MOTOR ASSEMBLY
 2. FUEL FILTER ASSEMBLY
 3. FUEL PUMP ASSEMBLY
 4. ELECTRIC PANEL ASSEMBLY
 5. AIR PRESSURE SWITCH
 6. COMBUSTION HEAD ASSEMBLY
 7. COMBUSTION CHAMBER
 8. COMBUSTION TEST
6. WIRING DIAGRAMS
7. TECHNICAL DATA SHEET

FIRE 115

L-S 116.00-BM



WARNING

The operations described in this booklet must be carried out by qualified and instructed personnel only. Incorrect maintenance may result in improper operation and serious injury.

1. CONTROLS AND COMPONENTS

INFRARED HEATER: FIRE 115

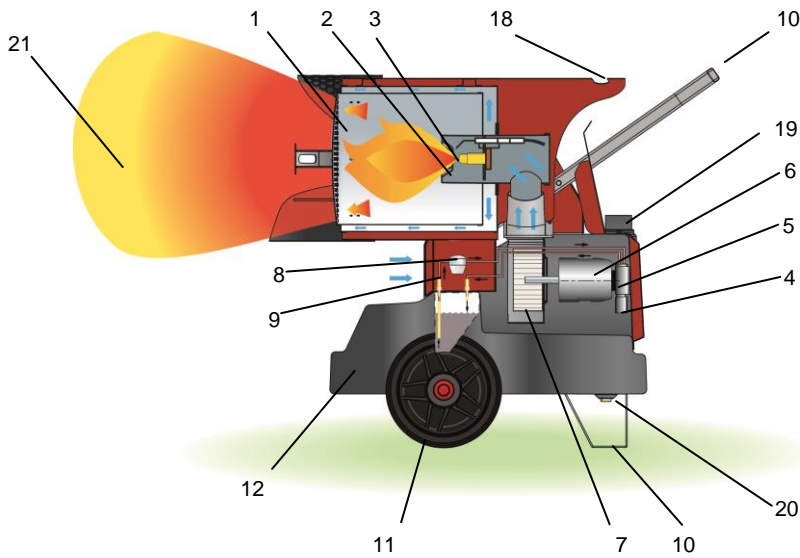

- 1 COMBUSTION CHAMBER
- 2 BURNER
- 3 NOZZLE
- 4 SOLENOID VALVE
- 5 DIESEL PUMP
- 6 MOTOR
- 7 FAN
- 8 FUEL FILTER
- 9 FUEL CIRCUIT
- 10 SUPPORT/HANDLE
- 11 WHEEL
- 12 FUEL TANK
- 13 RESET BUTTON WITH CONTROL LAMP
- 14 MAIN SWITCH
- 15 ROOM THERMOSTAT PLUG
- 16 CONTROL LAMP
- 17 POWER CORD
- 18 HANDLE
- 19 FUEL CAP
- 20 DRAIN PLUG
- 21 HEAT FLOW

CONTROL PANEL

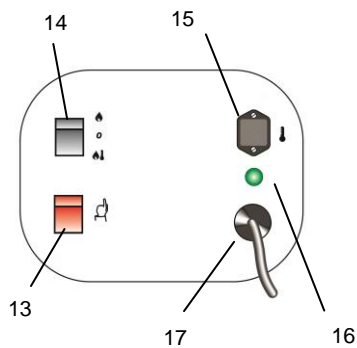

CONTROL SYSTEM

The heater has all operational controls located in a watertight control panel mounted on a lateral side of the unit.

The control panel consists of:

- a 3-position switch for heating function: normal operation, stop or thermostat operation
- plug to connect a remote room thermostat
- power cord
- control flame box to handle starting / running cycle (see paragraph 2.).
The control flame box is equipped with a reset button and a high voltage transformer that generates a spark to ignite the flame.

The control system utilizes:

- a safety shut off switch that is a overheat thermostat shutting down the unit if the temperature of combustion chamber and outlet air exceed the maximum allowed level
- a flame detector, that is a photocell monitoring constantly the flame presence and its integrity.
- a pair of ignition rods to create the ignition spark

FUEL SYSTEM

The fuel system consists of:

- fuel tank, that is made of plastic, shock absorption and fuel resistant. It has a drain plug located underneath the fuel tank to allow discharge of residual fuel before cleaning.
- fuel filter
- fuel pump. A screw fitted on the fuel pump allows the adjustment of fuel pressure setting
- fuel ON/OFF solenoid valve
 - during normal operation the valve is open and the pressurized fuel flows to the nozzle, where it is atomized, mixed with primary combustion air and ignited by the electrode spark
 - during abnormal operation (see paragraph 2.) the flame control unit closes the fuel solenoid valve and the unit stops.
- fuel circuit, including suction and return hoses from fuel tank to fuel pump and high pressure microhose from fuel pump to nozzle
- burner head
- nozzle

COMBUSTION CHAMBER

It consists of the internal combustion chamber (stainless steel made) that contains the flames and exchanges heat with the main airflow stream.

BURNER HEAD

The burner head is the assembly that determines the correct mixing of combustion air and fuel inside the combustion chamber and it consists of:

- Fuel nozzle
- Nozzle support
- Flame diffuser
- Air opening baffle: a screw fitted on the burner head allows the adjustment of combustion air setting
- Ignition electrodes
- Flame detector



FAN – MOTOR ASSEMBLY

The electric motor drives the fuel pump assembly and a fan which blows air inside and around combustion chamber.

2. FLAME CONTROL CYCLES

2.1 RESET LAMP LIGHT

During the operating condition, the reset button may have different type of light depending of its operating status (FUNCTION LIGHT):

-  light off: unit is in stand-by status (waiting for heating request) or starting cycle or running.
-  steady red light: the heater stops permanently in lock-out status and can restart only if reset button is pressed.
To troubleshooting the unit when it is in lock-out condition, press the reset button for about 5 seconds and then release it. A diagnostic routine is enabled, causing the reset button on the main board to flash (SELF-DIAGNOSIS LIGHT) with the following description

	Number of blinks	Fault description
	2	Flame failure in starting cycle
	4	Extraneous light / flame in starting cycle
	7	Flame failure in running cycle
	8 - 14	Internal failure of electronic control

2.2 OPERATING CYCLES

Depending on the type of the operating cycles, the main components (room thermostat, fan, ignition transformer, fuel valve) and controls element (photocell, reset button) are activated or de-activated according to specific rules and times.

In the following diagrams are shown:

- Starting cycle
- Shut off cycle
- Flame failure in starting cycle
- Extraneous light or flame during starting cycle
- Flame failure in running cycle

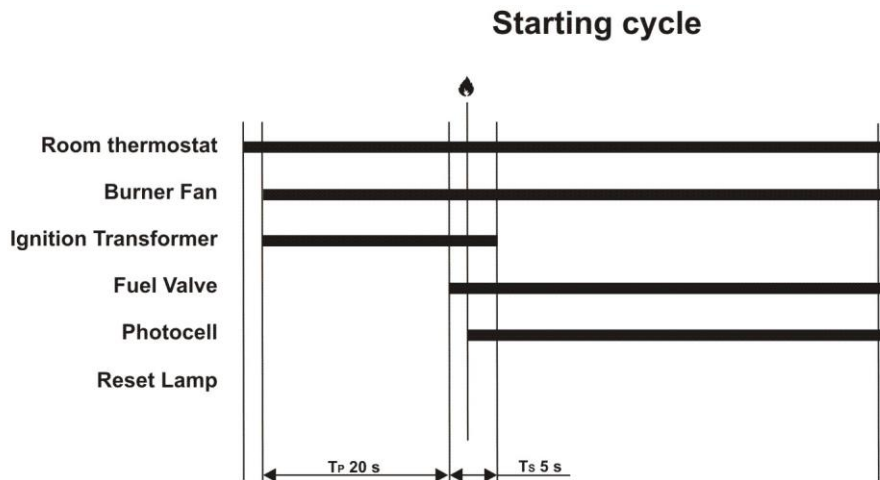

The flame control unit starts the sequence of operation after a heating request (normal operation or thermostat operation) and it consists of the following steps:

- Self-test (less than 3 s): self-check of electronics efficiency;
- Purging time T_p (20 seconds): fan motor and ignition transformer are simultaneously switched on while the fuel valve remains closed to eliminate any fuel or unburnt residual.

During the purging stage, the flame signal is constantly monitored and any kind of failure leading to combustion prevents the burner ignition causing the controls to lock out the unit.

In case of heating request opening (room thermostat opening), the control unit goes to stand-by position. The device remains in this status till closing of the room thermostat;

- Safety time (5 seconds): at the end of the purging time T_P , the fuel valve is switched on and opens the fuel to the nozzle.

In case of flame detection failure by the end of the T_S safety time, the control unit goes to lockout, and the fan motor, the ignition transformer and the fuel valve are de-energized, while the lockout signal is enabled.

Otherwise, at the end of the T_S safety time the control unit disables the ignition transformer and goes to running position.

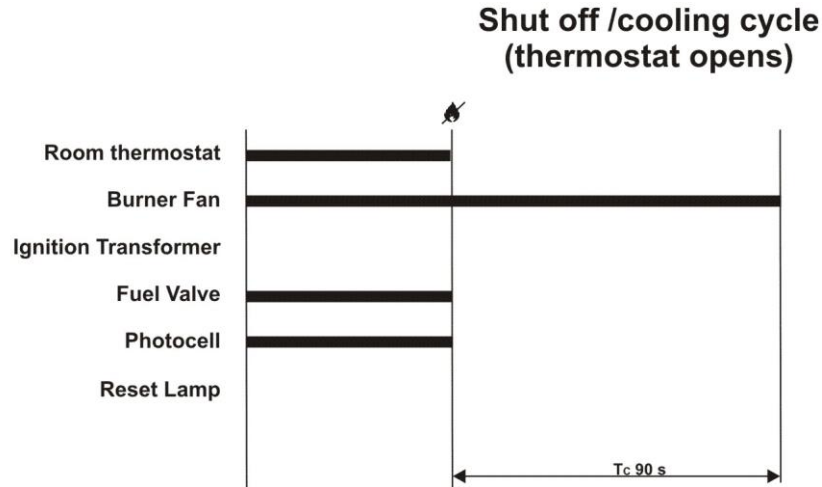

When the heating request (normal operation or thermostat operation) opens:

- fuel valve and ignition transformer are switched off and the flame lights off;
- burner fan operates a 90 s post-purge ventilation

Restoring the heating request causes the post-purge to be interrupted and the starting cycle to be performed.

Flame failure in starting cycle (two trial recycling)

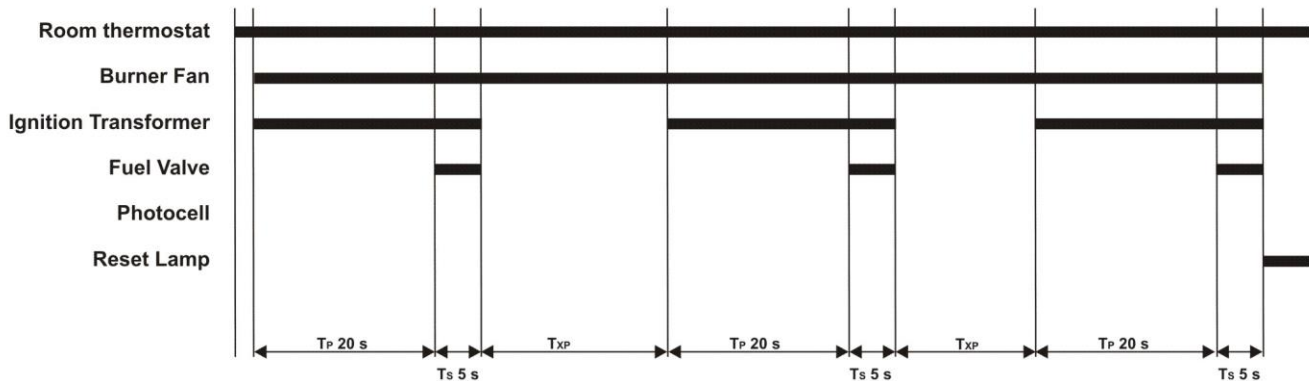

If during the safety time T_S , the photocell monitors a flame failure (signal to photocell become lower than minimum), at the end of safety time the unit tries to restart twice: should the flame failure being confirmed, then the unit goes in lock out:

- burner fan, ignition transformer and fuel valve are de-energized;
- alarm lamp on reset button becomes steady red

If troubleshooting on reset button is activated as described in 2.1, then the alarm lamp on reset button starts flashing with 2 blinks.

FUNCTION LIGHT: steady red

SELF-DIAGNOSIS LIGHT: flashing red with 2 blinks

Unit can re-start only after pressing the reset button.

NOTE: While starting cycle is repeated, a cooling time T_{XP} is required to get the ignition transformer be ready to operate.

Extraneous light / flame during pre-purge time T_P

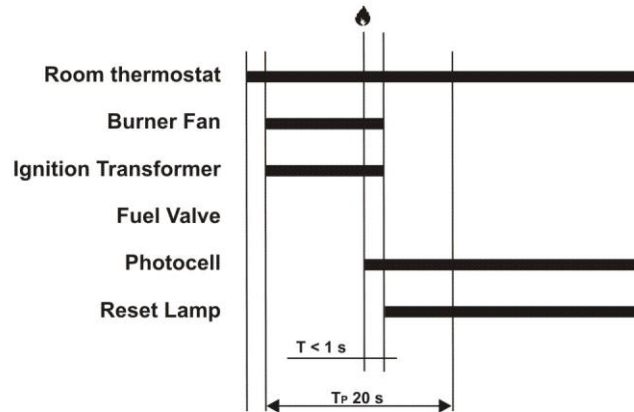

If during the pre-purge time the photocell monitors any residual flame then the unit goes in lock out:

- burner fan stop to purging combustion chamber
- fuel valve and ignition transformer are de-energized
- reset lamp becomes steady red

If troubleshooting on reset button is activated as described in 2.1, then the alarm lamp on reset button starts flashing with 4 blinks.

FUNCTION LIGHT: steady red

SELF-DIAGNOSIS LIGHT: flashing red with 4 blinks

Unit can re-start only after pressing the reset button.

Flame failure in running cycle (one trial recycling)

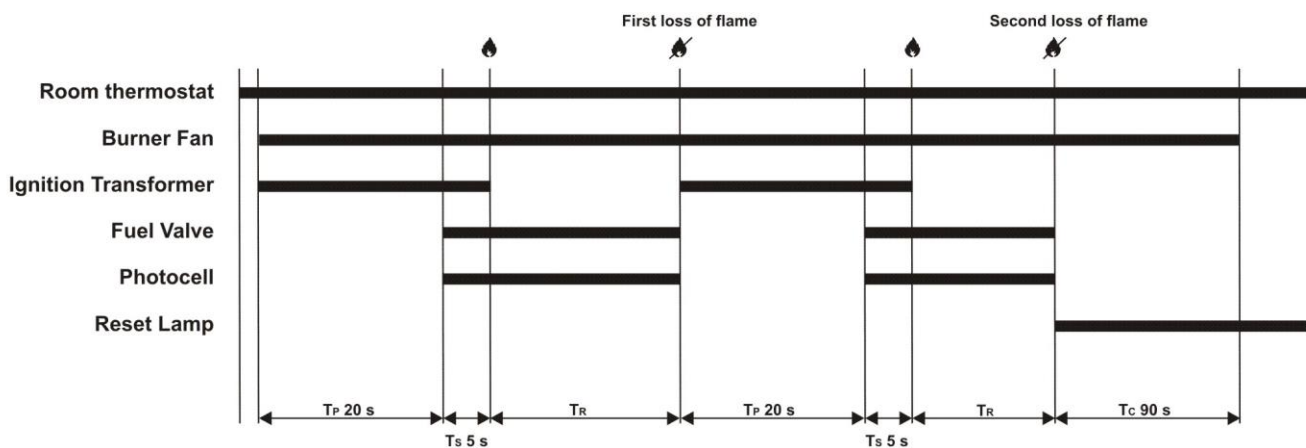

In case of flame failure in running status, the flame control unit makes one trial restarting the unit.

If the reason of flame failure is confirmed, then the unit stops in lock-out mode, and the reset lamp becomes steady red.

If troubleshooting on reset button is activated as described in 2.1, then the alarm lamp on reset button starts flashing with 7 blinks.

FUNCTION LIGHT: steady red

SELF-DIAGNOSIS LIGHT: flashing red with 7 blinks

Unit can re-start only after pressing the reset button.

3. MAINTENANCE SCHEDULE

Periodic maintenance of the heater is necessary to ensure proper performance and to prevent failures and it shall be performed at the following periodic intervals:

- **Daily maintenance**
 - Inspect air inlet / air outlet, remove debris if any
 - Verify fuel tank is full
 - Verify there is not any visible leaks
- **Weekly maintenance**
 - Inspect fuel filter and replace if necessary
 - Disassemble burner head
 - Inspect and clean burner diffuser
 - Clean ignition electrodes and adjust settings
 - Inspect the fuel hose assembly and check for any leaks
- **Monthly maintenance**
 - Disassemble burner head
 - Inspect and replace nozzle if necessary
 - Check air combustion setting
 - Check overheat thermostat
 - Inspect and clean the combustion chamber
 - Open electric board, inspect electrical components and check connections
 - Check fuel pressure setting of fuel pump - ensure 166 psi
 - Inspect and test the burner when maintenance has been completed

4. TROUBLESHOOTING GUIDE

PROBLEM	RESET BUTTON (13)		CAUSE	REMEDY	
• Motor does not start, no ignition	• Off	-	• Wrong setting of room thermostat or other control	• Check correct setting of heater control. If thermostat, make sure selected temperature is higher than room temperature	
			• Defective thermostat or other control	• Replace control device	
• Fan does not start or stops during start-up or heating	• Off	-	• No electrical current	• Check mains • Check proper positioning and functioning of switch • Check fuse	
			• Voltage below 68 V	• Check supply voltage: heater will restart automatically when voltage exceeds 78 V	
			• Voltage above 147V	• Check supply voltage: heater will restart automatically when voltage is below 138 V	
• Fan stops during start-up or heating	• Steady red	SELF-DIAGNOSIS LIGHT	4 blinks	• Presence of flame before transformer ignites • Defective photocell	• Clean and eliminate diesel residue in combustion chamber • Replace photocell
			2 blinks or 7 blinks	• Defective electrical motor	• Replace electrical motor
				• Defective electrical motor bearings	• Replace electrical motor bearings
				• Burned out condenser	• Replace condenser
				• Defective electric ignitor	• Check connection of H.T. wires to electrodes and transformer
					• Check electrodes setting (see scheme "SETTING THE ELECTRODES")
					• Check electrodes for cleanliness
				• Replace H.T. transformer	
			• Defective flame control box	• Replace control box	
			• Defective photocell	• Clean or replace photocell	
			• Insufficient or no fuel at burner	• Check state of motor-pump plastic coupling	
				• Check for any air infiltrations in the fuel line by checking the air-tightness of the pipes and of the filter.	
				• Clean or replace oil nozzle	
• Defective solenoid • Defective electric ignitor	• Check electrical connection				
	• Check thermostat LI				
• Clean solenoid valve and replace it if necessary					
8 – 14 blinks	• Internal error of electronic control board	• Reset the device and attempt at least two starts. If the problem persists, replace the electronic control board			
• Fan starts and flame lights, generating fumes	• Off	-	• Insufficient combustion air	• Check the position of the air regulation ring • Clean burner disc	
			• Excess combustion air	• Check the position of the air regulation ring	
			• Fuel contaminated or contains water	• Drain fuel in tank and load with clean fuel • Replace oil filter	
			• Air leaks in fuel circuit	• Check the seals on the ducts	
			• Insufficient fuel at burner	• Check pump pressure • Clean or replace fuel nozzle	
			• Excess fuel at burner	• Check pump pressure • Replace nozzle	
• Heater does not stop	• Off	-	• Defective solenoid seal	• Replace complete solenoid valve	

5. REPAIR PROCEDURES



Before carrying out any maintenance operation the heater must be disconnected from power supply. Refer to instruction manual to fully stop the heater. Therefore:

- Stop the machine as instructed
- Turn off the disconnecting switch on the main electric switchboard
- Wait until the heater has cooled.

Never service heater while it is plugged in, operating or hot.
Severe burns or electrical shock can occur.

1) FAN MOTOR ASSEMBLY

a) To clean the fan blades and motor, carry out the following procedure.

i) Remove the bottom and upper rear cover access panel (a) by removing four screws



ii) Remove fan/motor assembly (c) by removing four screws that secure it to the machine.

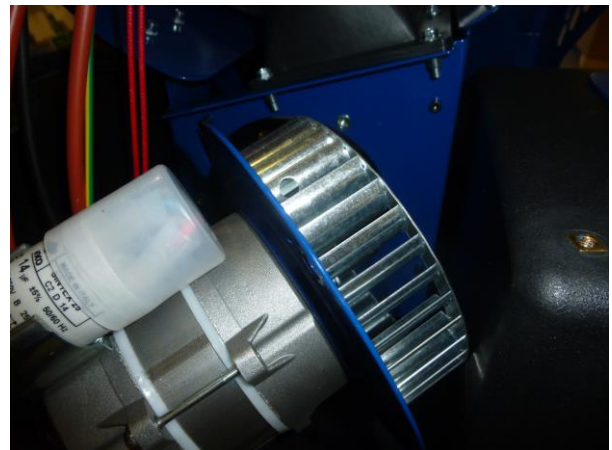

iii) Inspect and, if necessary, clean the motor using compressed air, being carefully not to direct the air jet to the air pressure switch gauge (c) (the pressure switch could be damaged)

iv) Clean the fan blades and plastic conveyor using a stiff brush.

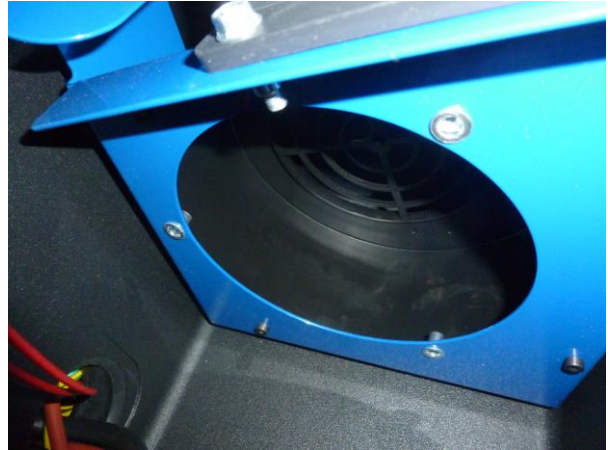
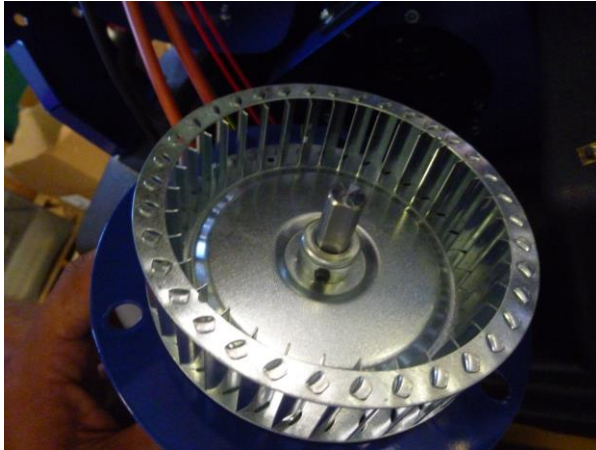

- v) Reinstall the fan/motor assembly
- vi) Reinstall cover panels.

b) To replace the fan blade and the electric motor, carry out the following procedure.

- i) Remove the fan/motor assembly as by previous steps
- ii) Loosen the screw (c) on the fan hub

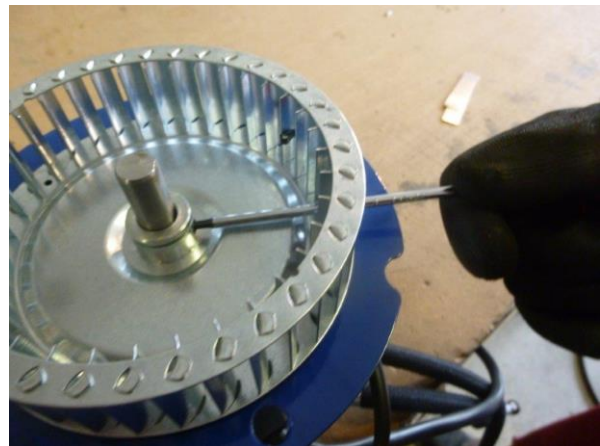
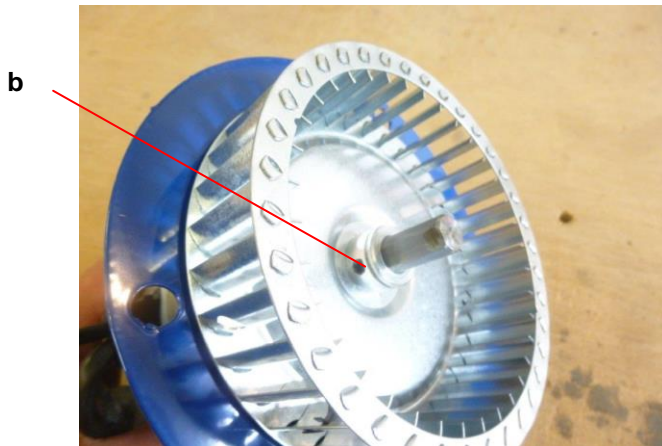

- iii) Extract the fan
- iv) Remove the fan flange (c) by removing four screws

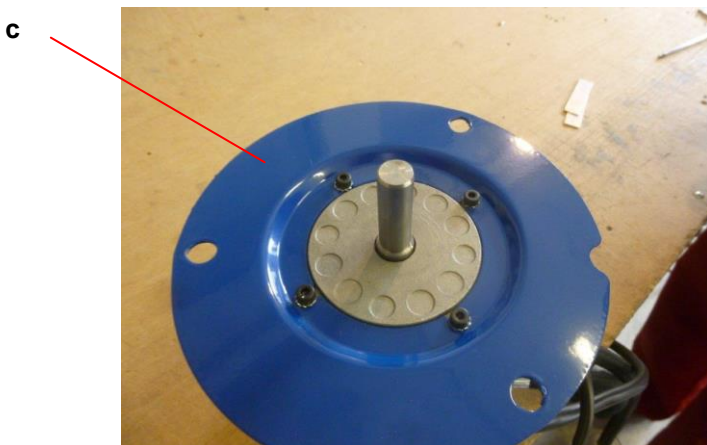

- v) Loosen three screws (e) on the fuel pump casing (be sure not to remove the screws)
- vi) Remove fuel pump from electric motor and keep plastic coupling for next reassembling



- vii) Open main electric board on side/front of the heater
- viii) Trace the electric motor power cords and disconnect the three wires (white, black, green) from control panel
- ix) Position a new motor on the motor flange and reassemble four screws (f) to fix it
- x) Check alignment of the motor to the heater axis and tighten four screws (f) on motor flange
- xi) Fit fuel pump on electric motor being sure that plastic coupling is aligned and tighten three screws (e)
- xii) Position fan blade on the motor shaft being sure that the quoted distance is 1 mm

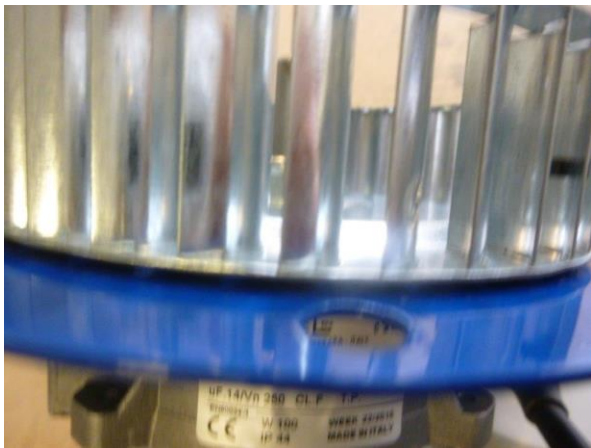

- xiii) Tighten screw (d) and check free rotation of the fan blades
- xiv) Reinstall covering panels.

2) FUEL FILTER ASSEMBLY

To replace the plastic type fuel filter, carry out the following procedure.

- i) Remove front panel (a)

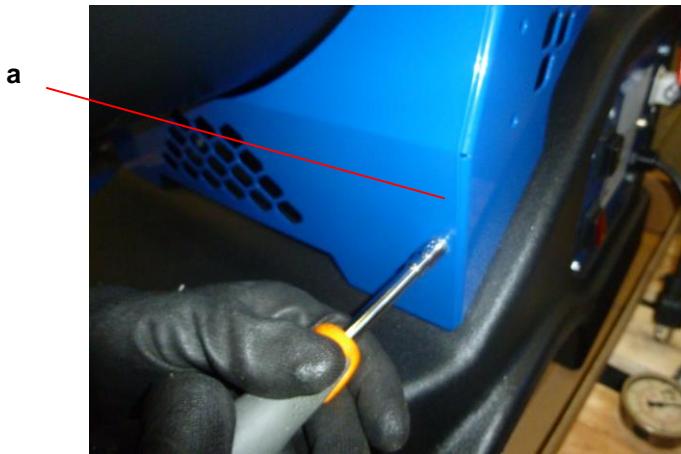

- ii) Remove clips (b) and fuel hoses



- iii) Replace fuel filter
- iv) Reassemble the filter assembly checking clips (a) are tightened

3) FUEL PUMP ASSEMBLY

a) To replace fuel pump, carry out the following procedure.

i) Remove the bottom and upper rear cover access panel (a) by removing all screws



ii) Remove fan/motor assembly

iii) Loosen three screws (e) on the fuel pump casing (be sure not to remove the screws)

iv) Remove fuel pump from electric motor and keep plastic coupling for next reassembling



v) Disconnect wires lead to fuel solenoid valve (g)

vi) Reassemble new fuel pump on electric motor being sure that plastic coupling is aligned

vii) Tighten three screws (e)

viii) Reinstall the cover.

b) To set fuel pressure on fuel pump, carry out the following procedure.

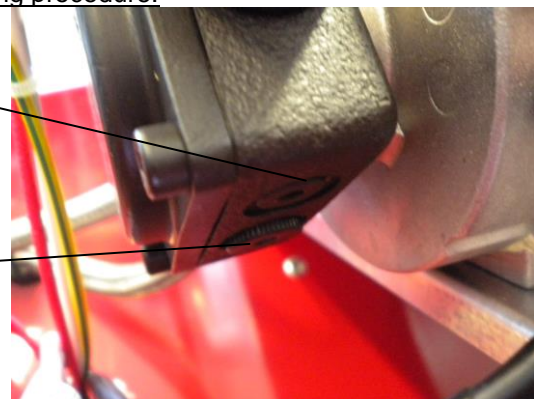

- i) Remove the rear cover access panel (b) by removing all screws
- ii) Loosen cap (a) on side of fuel pump and connect a fuel pressure meter
- iii) Disconnect wires lead to fuel solenoid valve (to avoid fuel spray inside combustion chamber)



WARNING

**The following operation shall be done with top cover and possible access to rotating fan.
Fan rotating area is covered by fan support even if accessible
Take measure to avoid touching any rotating parts while setting fuel pressure**

- iv) Start the heater and check the fuel pressure be the value listed in the final technical sheet
- v) Correct the pressure by screwing (to increase pressure) or unscrewing (to decrease pressure) screw (b)

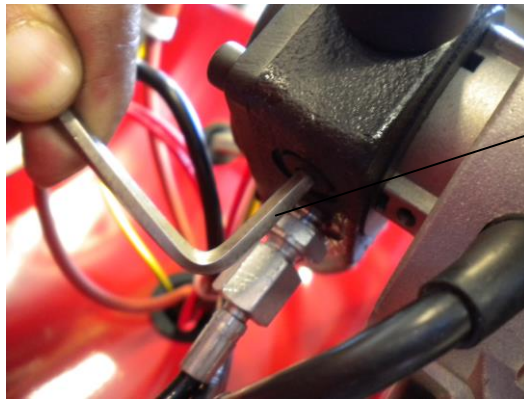

- vi) Remove fuel pressure meter and tighten cap (a)
- vii) Connect wires to solenoid fuel valve
- viii) Reinstall the top cover.

4) ELECTRIC PANEL ASSEMBLY

- a) To check electric control board and its fuse, carry out the following procedure.
 - i) Remove four screws (a) on control board panel
 - ii) Remove front cover (b)

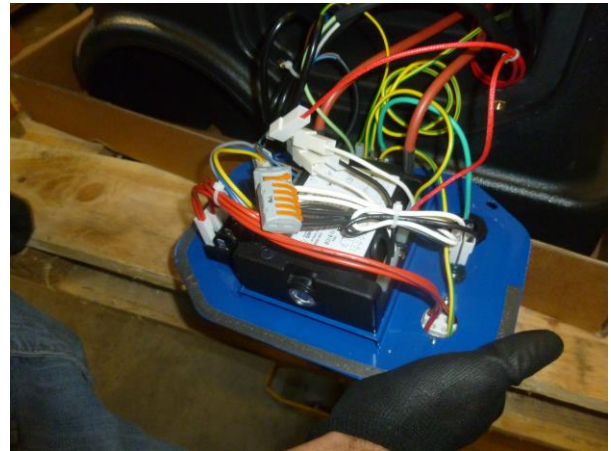
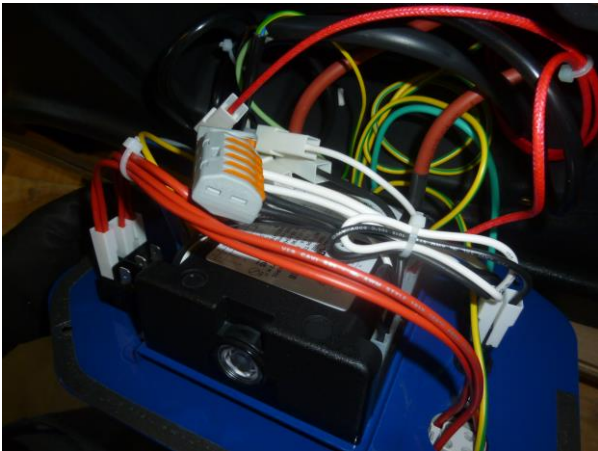
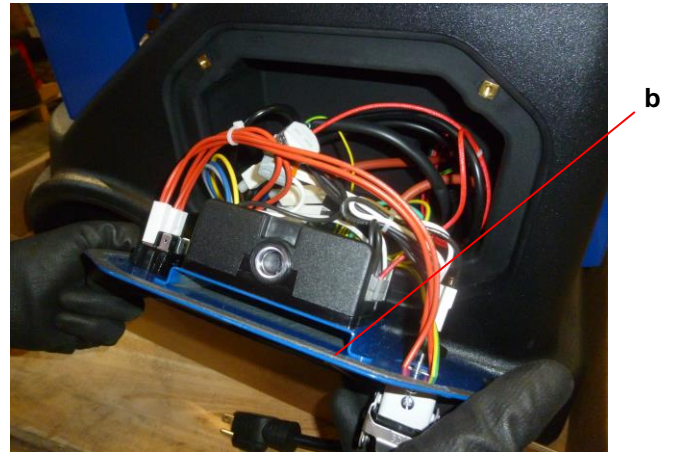
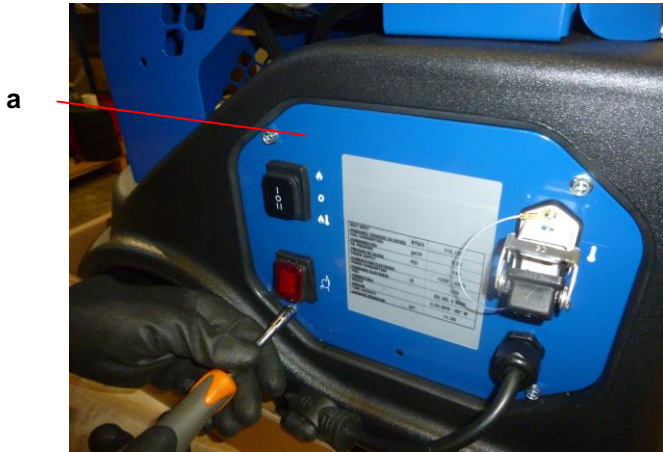

- iii) Check that all connections are complete and tight
- iv) To check fuse loosen $\frac{1}{4}$ clockwise the screw (c) , extract the fuse and check its integrity

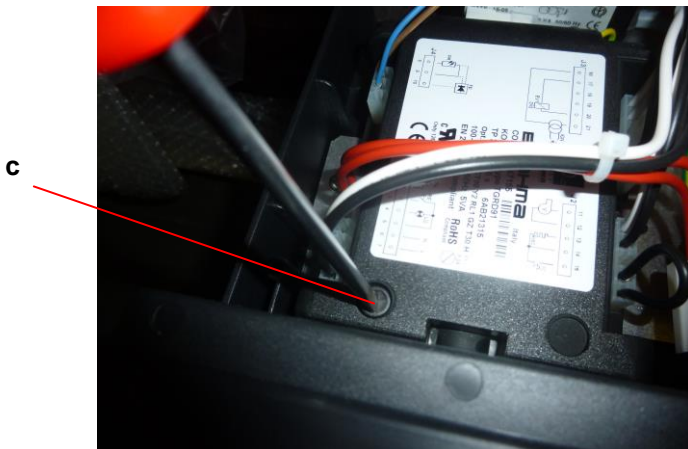

- v) If necessary, replace it with a new one
- vi) Reassemble front cover (b) and fix it to the heater

5) COMBUSTION HEAD ASSEMBLY

a) To clean combustion head assembly, carry out the following procedure.

i) Remove the bottom rear cover access panel (a) by removing four screws



ii) Remove the upper rear cover access panel (b) by removing four screws



iii) Loosen screw (c) and remove fast-on connector of yellow/green wire (c)

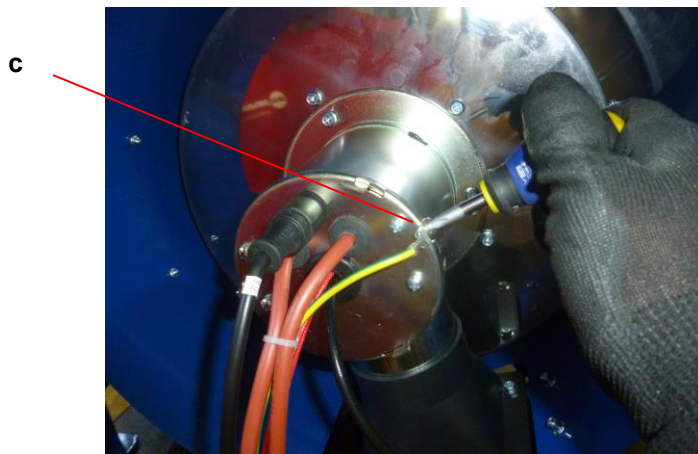

iv) Turn counterclockwise burner support (d) and pull it out of burner tube (e)

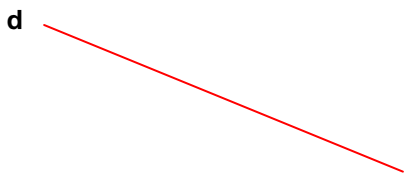

e

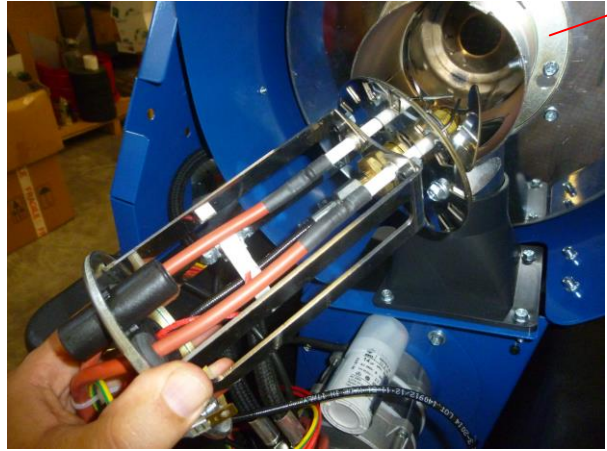

- v) Check / Clean diffuser ring (f)
- (1) be sure any debris or soot is eliminated on every wing and opening on front surface of ring
 - (2) if necessary loosen screws (g) and remove it to wash using clean diesel
 - (3) check for any damage or bended part: if any replace it

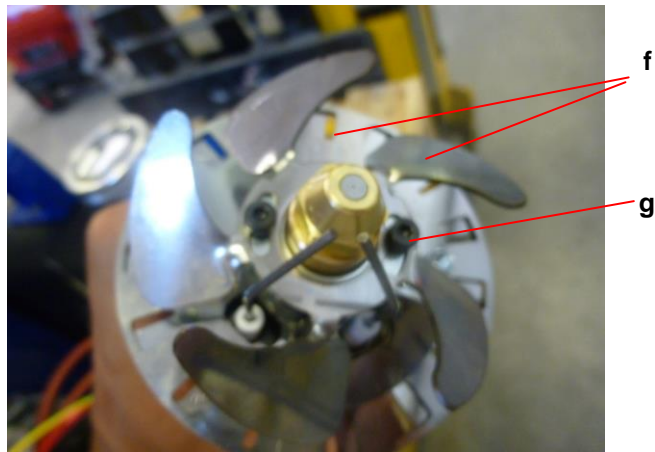

- vi) Check / clean ignition electrodes (h)
- (1) Clean and remove any debris or soot on sharp ends of electrodes
 - (2) If necessary remove both electrodes and replace
 - (3) Check alignment as by following image: electrodes shall be centered and symmetric

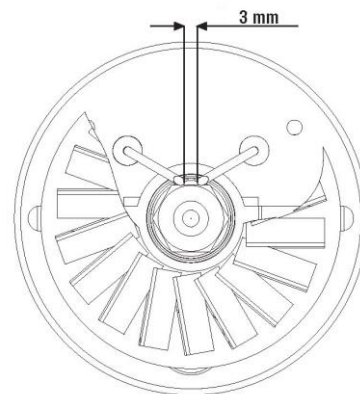
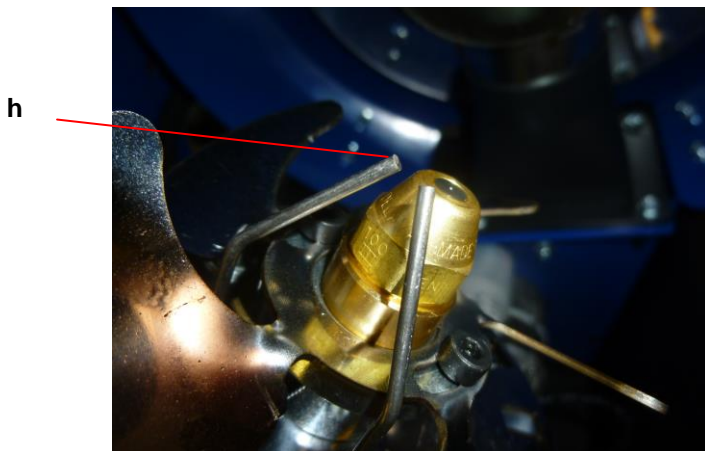

(4) Check electrode connectors (i) be tightened and clean

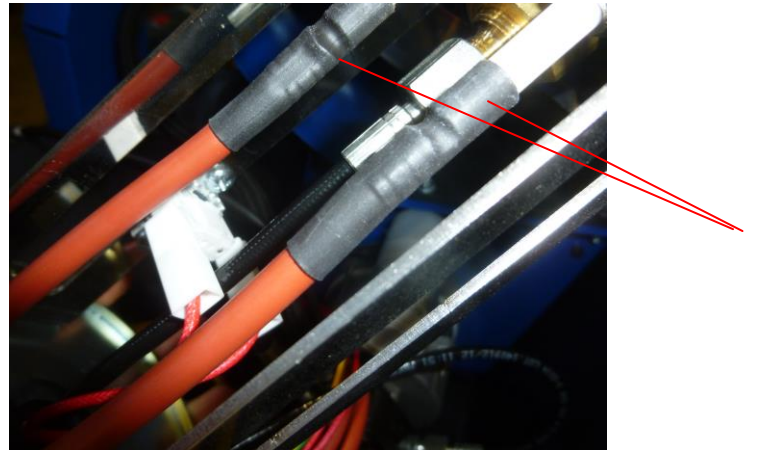

vii) Check/replace fuel nozzle
(1) Loosen fuel nozzle and place a new one

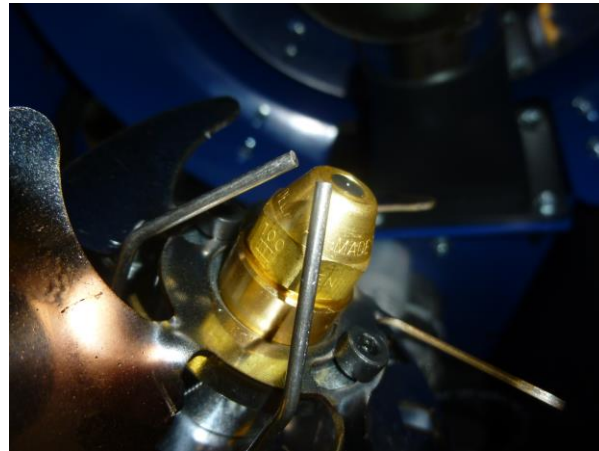

viii) Check / clean photocell
(1) Remove photocell (m) and check it is clean



(2) Check photocell support be clean and clean hole (n)

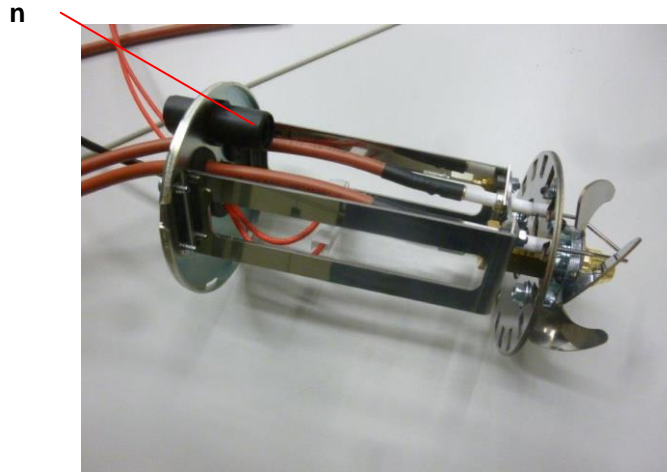

- ix) Check / adjust air openings
 - (1) Loosen nuts (o)
 - (2) Adjust rotating disc (p) until the requested opening is obtained (check final tech. sheet)

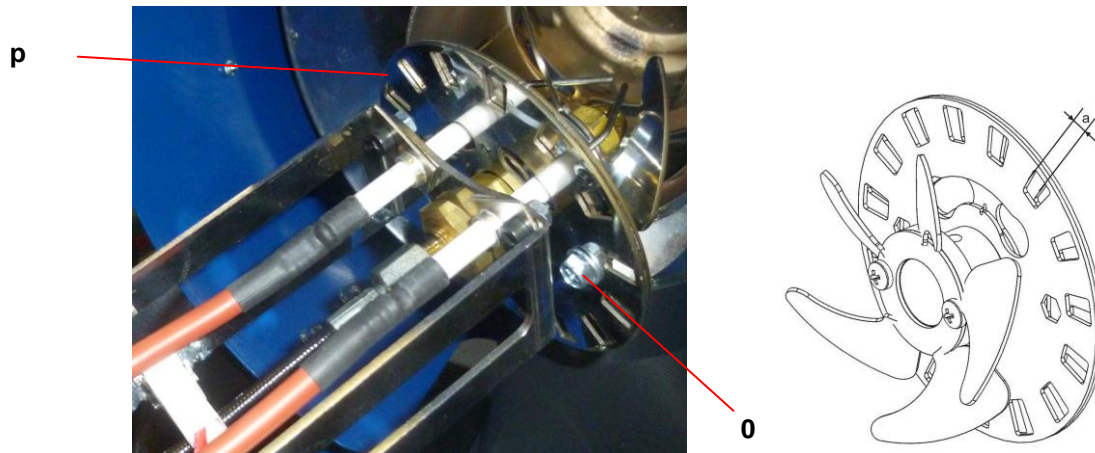

- x) Reassemble combustion head

6) COMBUSTION CHAMBER ASSEMBLY

- a) To clean combustion chamber assembly, carry out the following procedure.
 - i) Remove the front bumper
 - ii) Remove the outlet panel (a) by removing six screws

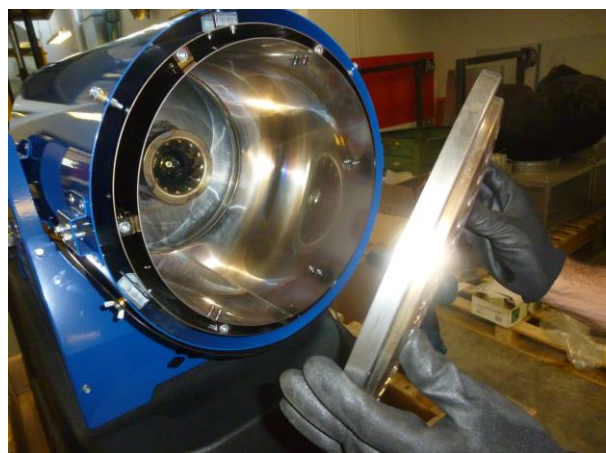

- iii) Check and clean inside combustion chamber with a cloth, removing liquid fuel residual
- iv) Reassemble outlet panel (a) and front bumper

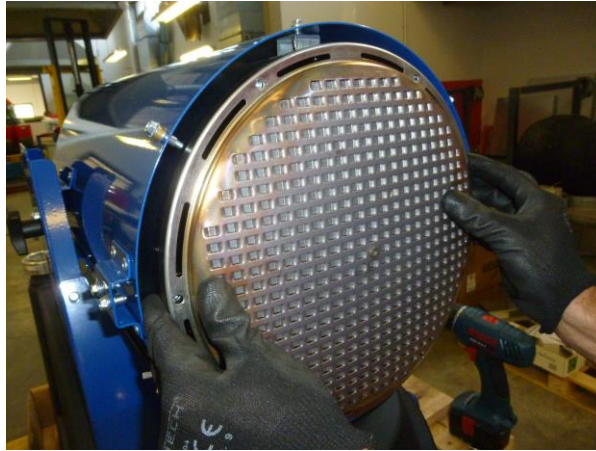

6. WIRING DIAGRAM

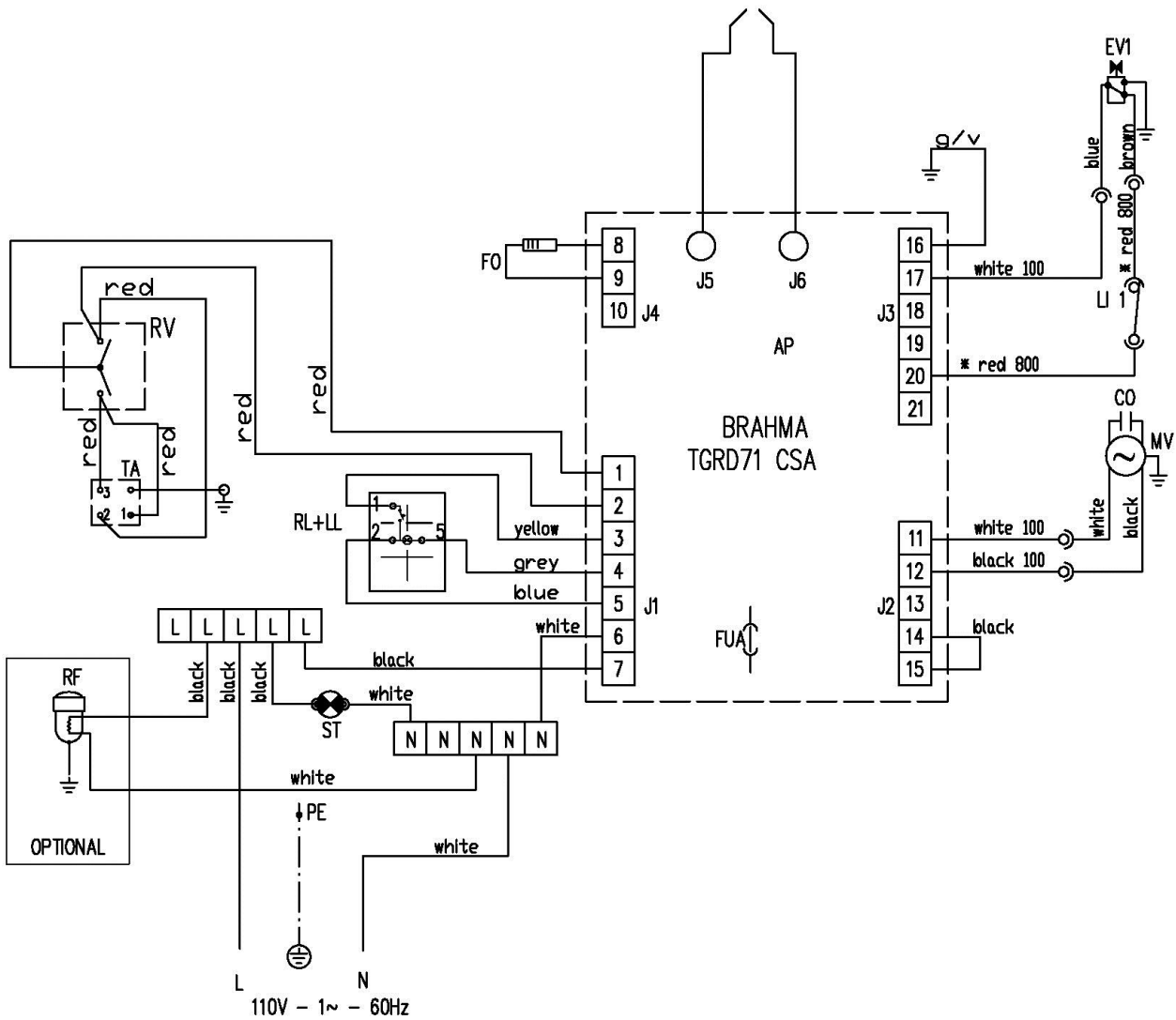

AP CONTROL BOX

TA ROOM THERMOSTAT PLUG

LI1 OVERHEAT THERMOSTAT

EV1 SOLENOID VALVE

FO PHOTOCCELL

CO CAPACITOR

MV BURNER MOTOR

FUA FUSE

RV SWITCH

ST ELECTRIC PILOT

RF HEATED FILTER >> OPTIONAL

RL RESET BUTTON

LL LOCK OUT INDICATOR LIGHT

RV1 SWITCH

TD TRANSFORMER H.V.

NOTE

Overheating thermostat LI1 is connected in serie to fuel valve EV1.

Therefore in case LI1 opens, the fuel valve EV1 is switched off and the flame control unit goes in lock-out in the "flame failure mode".

7. TECHNICAL SPECIFICATION

TECHNICAL SPECIFICATIONS CARACTERISTIQUES TECHNIQUES		FIRE 155	
Max heating output Puissance thermique max		[BTU/h]	115.159
Fuel consumption Consommation		[gal/h]	0,849
Power supply Alimentation électrique	Phase Phase		1
	Voltage Tension	[V]	120
	Frequency Fréquence	[Hz]	60
Power consumption Puissance électrique		[W]	175
Nozzle Gicleur		[USgal/h]	Delavan 0,65 - 80° W
Pump pressure Pression pompe		psi	166
Adjustment of combustion air flap Réglage du volet d'air comburant		[in]	a = 0,126
Tank capacity Capacité réservoir		[USgal]	11,35
Noise level at 1 m Niveau sonore à 1 m		[dBA]	69
Dimensions, L x W x H Dimensions, L x P x H		[in]	35.24 x 20.94 x 31.81
Weight Poids		[lb]	92.5

